

**ARMATURE DE SECURITE VHC**  
**DEFINITION SELON LES PERIODES**

**ET**

**N° DE SCHEMAS DES ARCHITECTURES DE L'ANNEXE K en Cours**

<b>Pour les voitures fermées T. CT. GT. GTS. GTP.</b>			
articles annexe VI	année	périodes	observations
1.1.2 (a)	jusq 61	<b>A à E</b>	Recommandé ou mini de période
1.1.2 (b modifié 14 janvier 2014)	62 à 65	<b>F (circuit et c/c)</b>	Minimum de période ou K1 ou K2
1.1.5 (c)	62 à 65 66 à 90	<b>F</b> <b>G1 à J2</b>	dito G1 (K3+D+2P) G1 maximum 6 points (+1 ou 2) K 13 K 17 K 23 sauf si + 6 spec de période K3 + portes + diag ar. G2 → J2 = + de 6 points si spec de période
1.1.5 (d)	82 à 90	<b>J1 et J2 G B + 1600cm3</b>	K3 + portes + diag ar. + toit + pare brise + tab bord + pieds arceaux

K1

K2

K3

1.2.2  
homologation  
: annexe VI  
ou A.S.N. ou  
de période  
F.H. en V.O.

N° de Schémas nécessaires pour renseigner à la **page 23 d'une demande PTH** dans le cas d'un arceau de construction :

***Annexe K en Cours*** Article 1.4(a), (b), (c)

***Système de Spécification de Période*** : Article 1.5(a), (b), (c), (d)

---

**ANNEXE V**

---

Dessins avec référence à l'Article 5.13 Arceaux et/ou à l'Annexe VI

Note: les nombres se réfèrent aux dessins situés juste au-dessus.



K-1

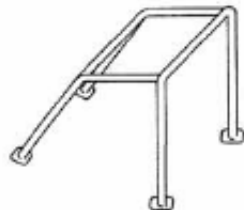

K-2

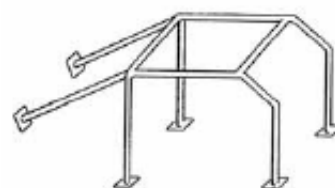

K-3

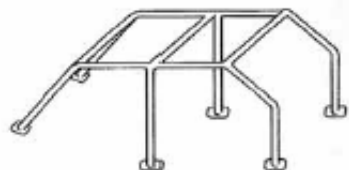

K-4



K-5



K-6

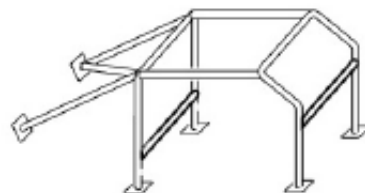

K7

---

**APPENDIX V**

---

Drawings referred to in Article 5.13 Rollbars and/or Appendix VI

Note that all drawing numbers relate to the drawing above the number.

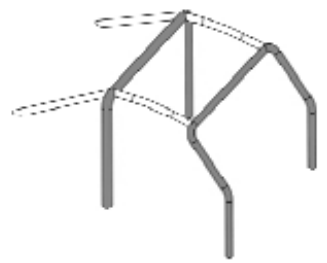

K-8

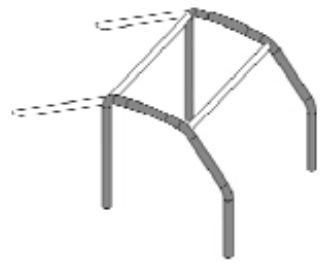

K-9

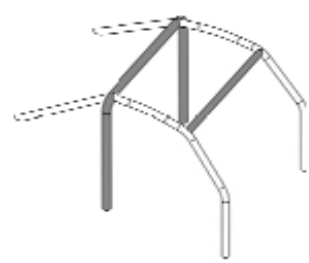

K-10

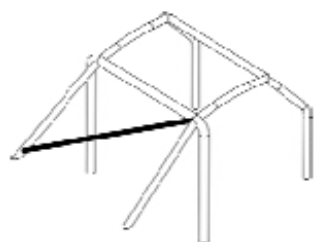

K-11

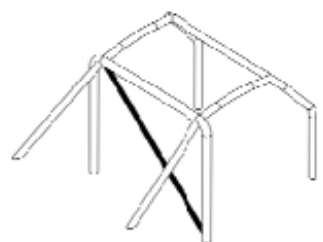

K-12

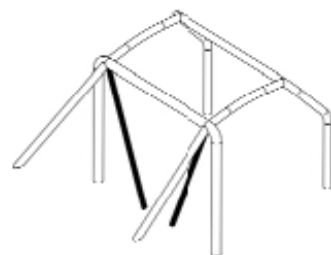

K-13

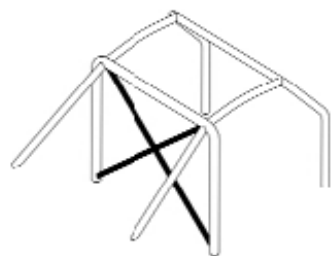

K-14

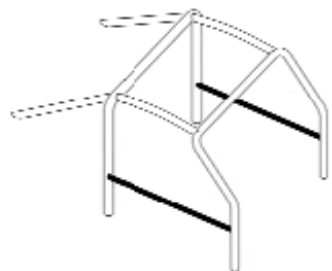

K-15

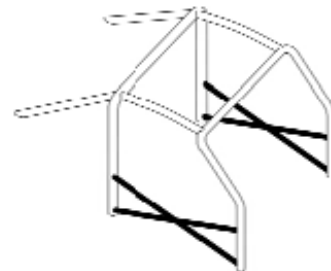

K-16

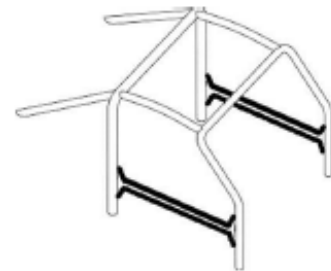

K-15 A

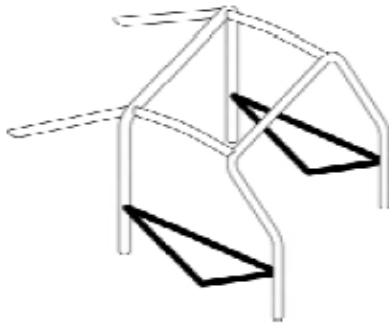

K-17

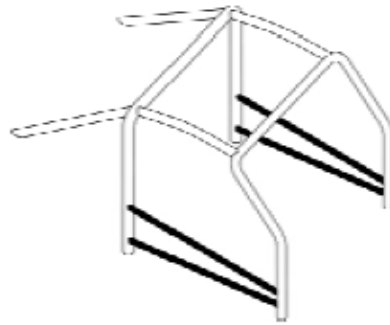

K-18

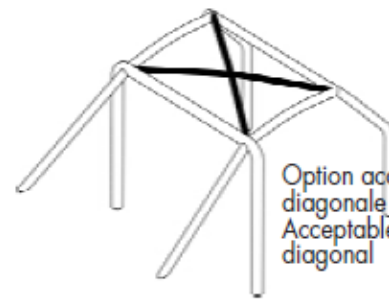

Option acceptable: 1 seule diagonale  
Acceptable option: just 1 diagonal

K-19

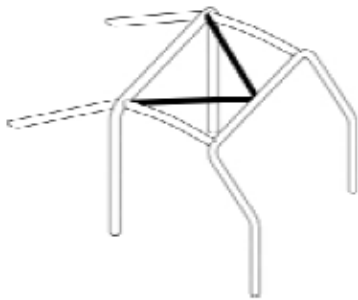

K-20

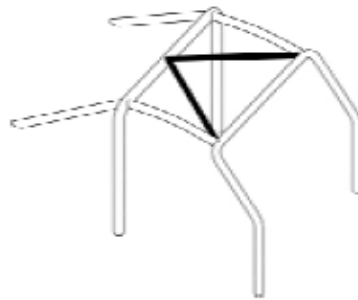

K-21

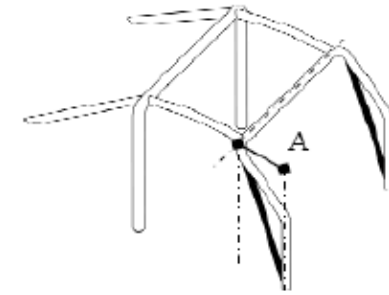

K-22

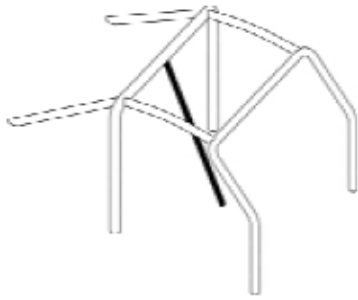

K-23

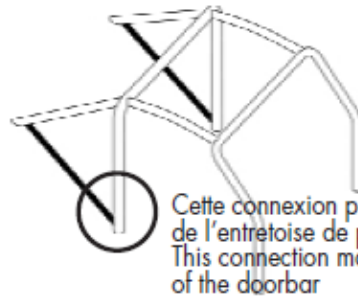

Cette connexion peut être au niveau de l'entretoise de portière  
This connection may be at the level of the doorbar

K-24

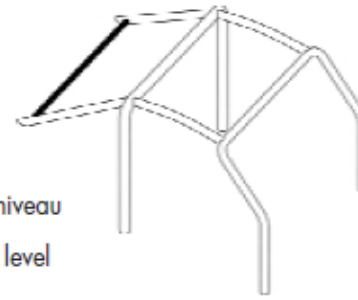

K-25

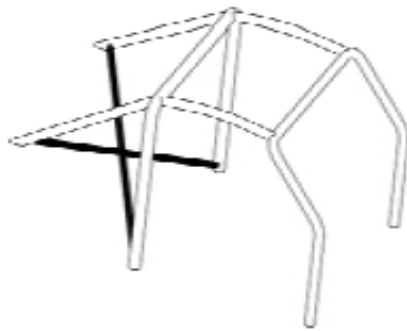

K-26

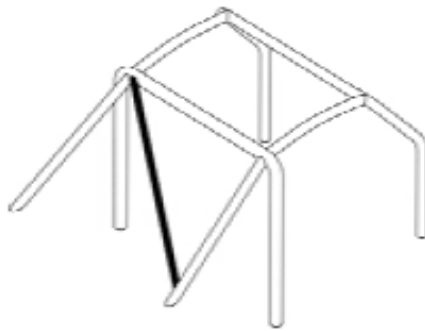

K-27

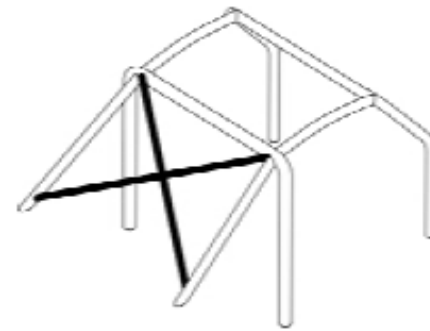

K-28

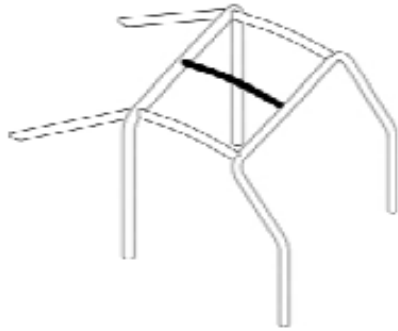

K-29

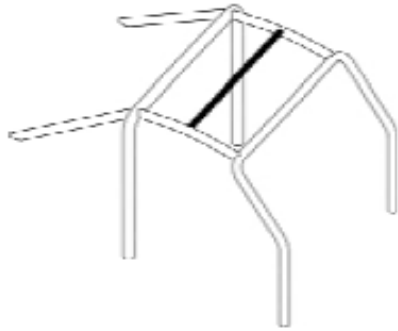

K-30

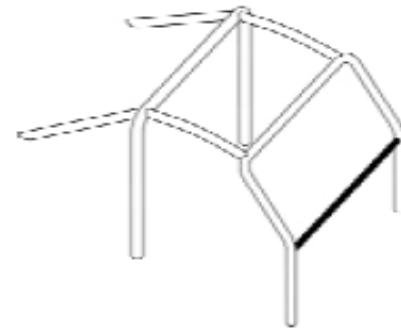

K-31

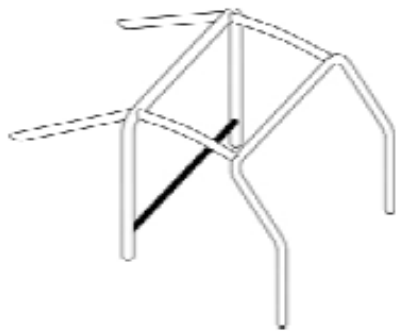

K-32

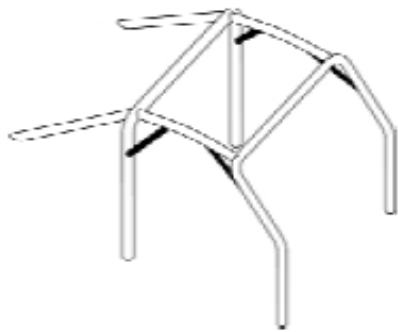

K-33

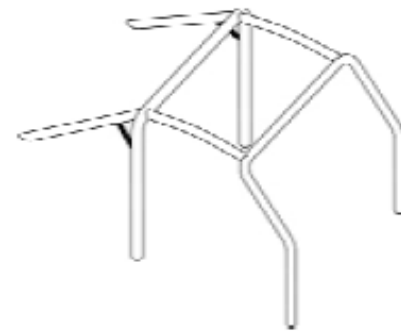

K-34

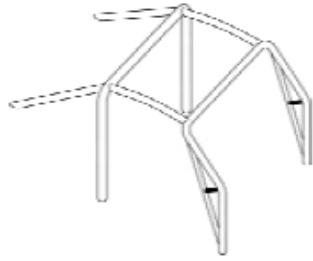

K-35

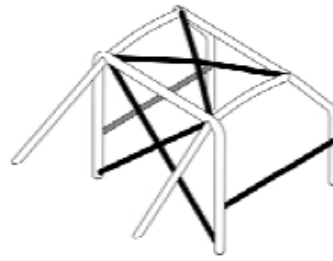

K-36

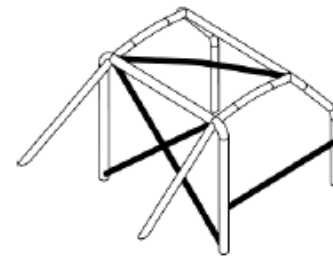

K-37

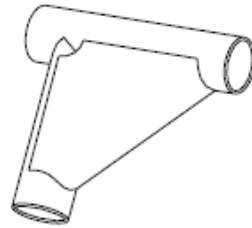

K-38

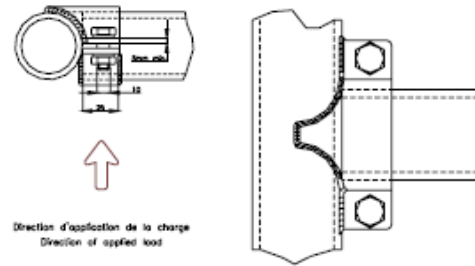

Direction d'application de la charge  
Direction of applied load

K-39

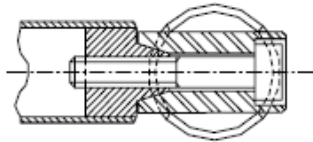

K-40

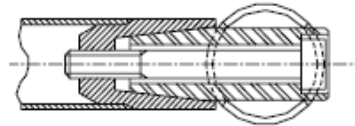

K-41

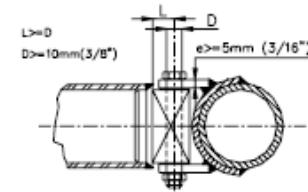

K-42

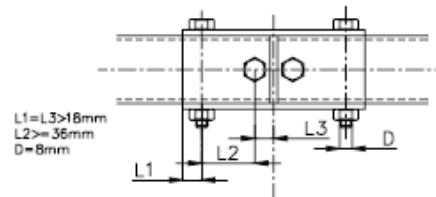

$L1 = L3 > 18\text{mm}$   
 $L2 \geq 36\text{mm}$   
 $D = 8\text{mm}$

K-43

$L1 = L3 > 36\text{mm}$   
 $D = 10\text{mm}$

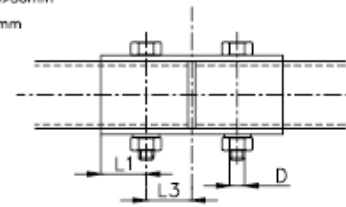

K-44

L doit être minimum  
La largeur de la patte doit  
être d'au moins 25mm

L must be minimum  
The clamp width must  
be at least 25mm

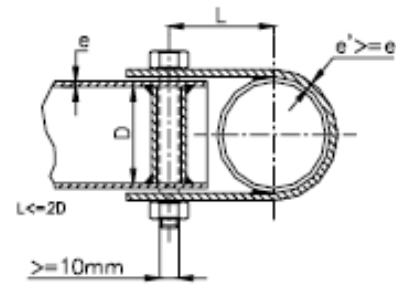

K-45

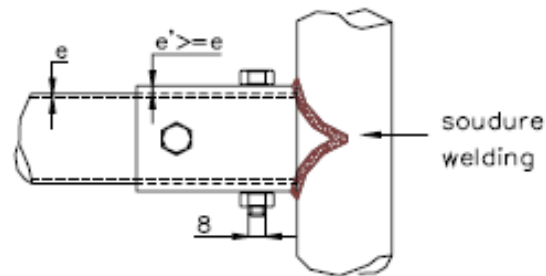

K-46

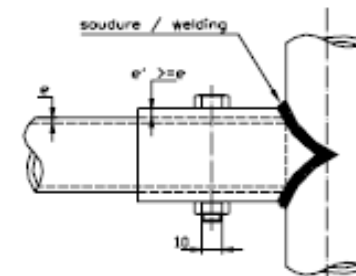

Dessin / Drawing N° 253-35

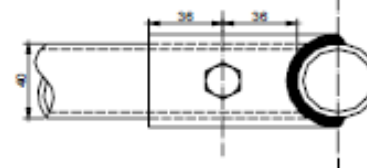

K-47

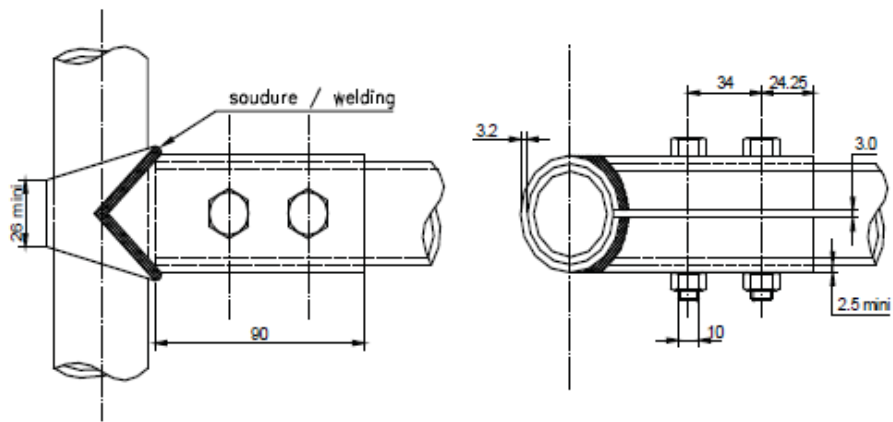

K-48

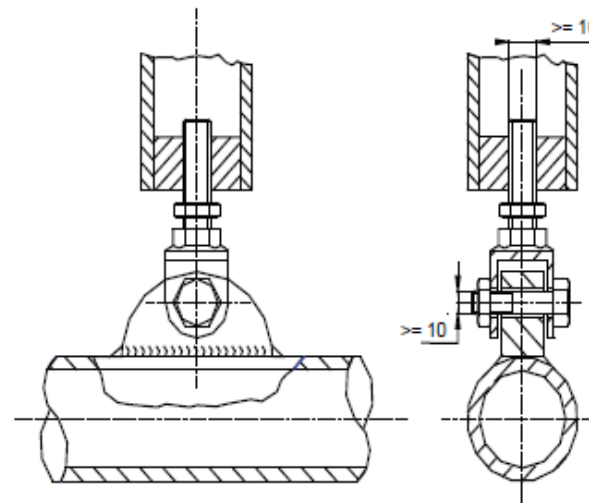

K-49

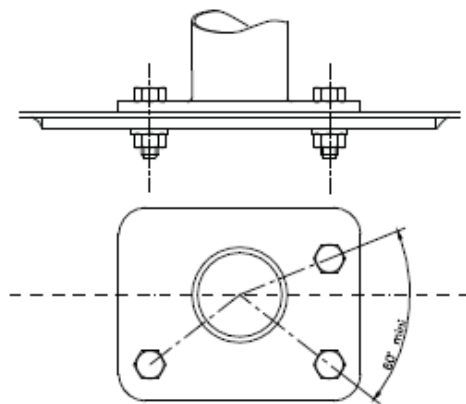

K-52

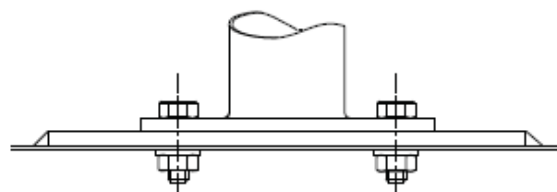

K-53

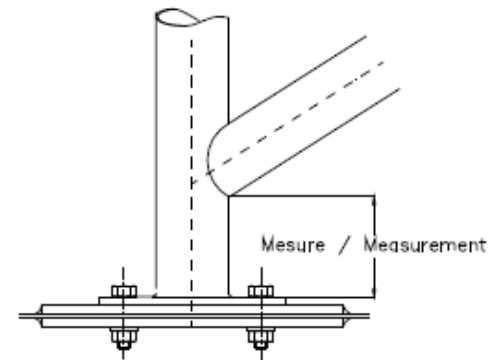

K-54



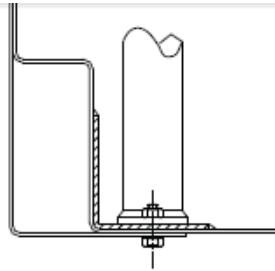

K-55

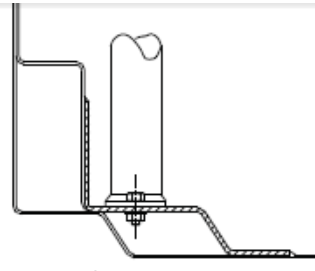

K-56

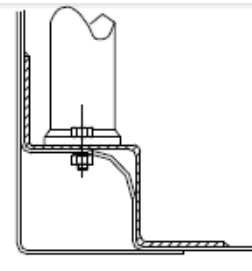

K-57

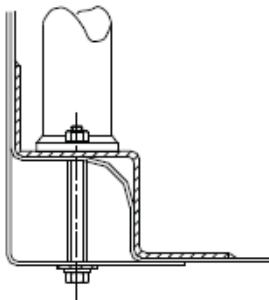

K-58

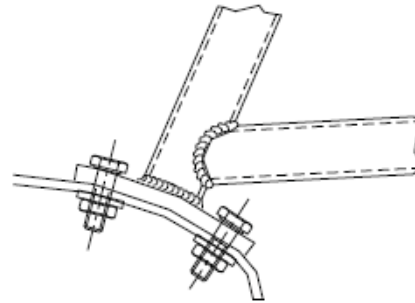

K-59

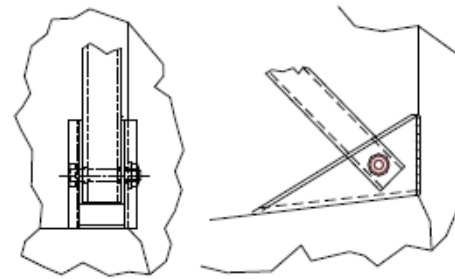

K-60

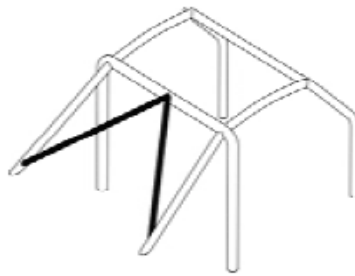

K-61

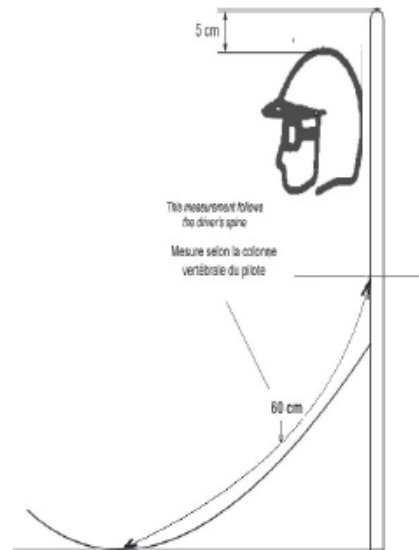

K-62

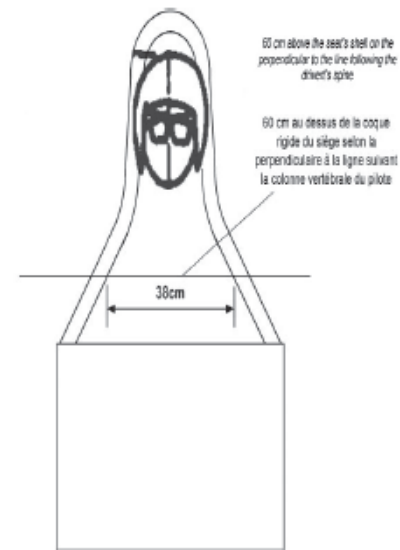

60 cm above the seat's steel on the perpendicular to the line following the driver's spine

60 cm au dessus de la coque rigide du siège selon la perpendiculaire à la ligne suivant la colonne vertébrale du pilote

38cm